

# Electric pump

## EL60A/B

PUMP SPECIFICATIONS	Mod. A	Mod. B
Capacity [m <sup>3</sup> /h]	200	350
Head [m]	26	20
Impeller diameter [mm]/type	440/3 blades closed	
Flanged bore size [DN.../PN...]	DN150/PN10	DN200/PN10
Cross section diameter [mm]	60	
Weight (without cable) [kg]	1005	1025

ELECTRIC MOTOR	
Power [kW-HP]	44-60
Voltage [V]/Current [A]	400/88
Phases/Poles/Frequency [Hz]	3/6/50
Speed [RPM]	980
Insulation class	H
Power cable 20m (IEC 60245- 4)	H07RN-F 4G35

MATERIALS	
Casing	Spheroidal cast iron EN-GJS-500-7 (EN 1563)
Motor housing	Cast iron EN-GJL-250 (EN 1561)
Wear parts	High chrome EN-GJN-HV600 (XCr18) (EN 12513)
Main shaft	High tensile steel 39NiCrMo3 (AISI 9840)

SEALS / LUBRICANT	
Motor side seals	2 lip seals (BUNA)
Impeller side seals	5 lip seals (3 BUNA + 2 PTFE) + 1 V-RING (TPU)
Oil type	ISO 320

DIMENSIONS [mm]							
H	W	D	F	H1	A	B	C
1610	935	725	545	1055	365	430	325

### PERFORMANCE CURVES

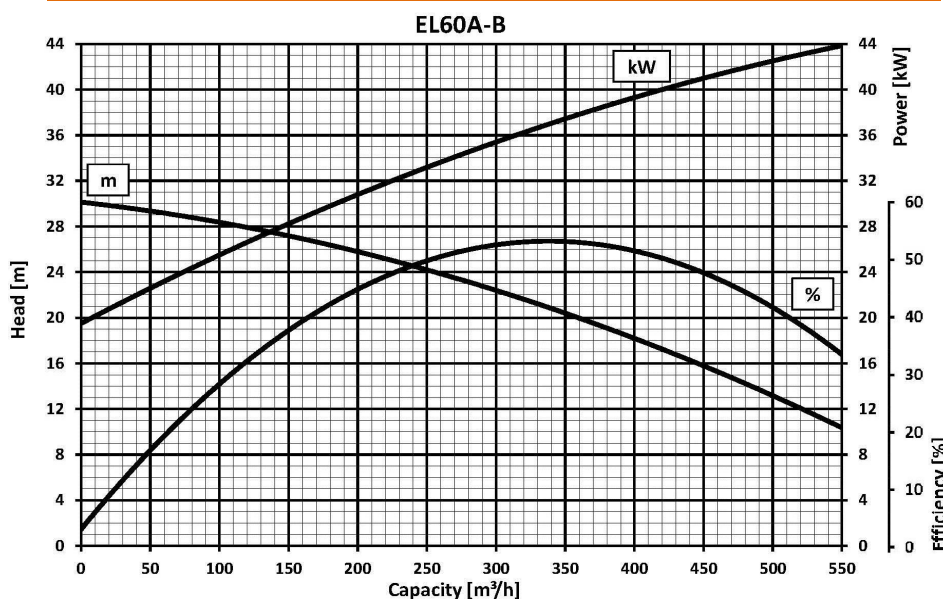

We reserve the right to make changes without notice

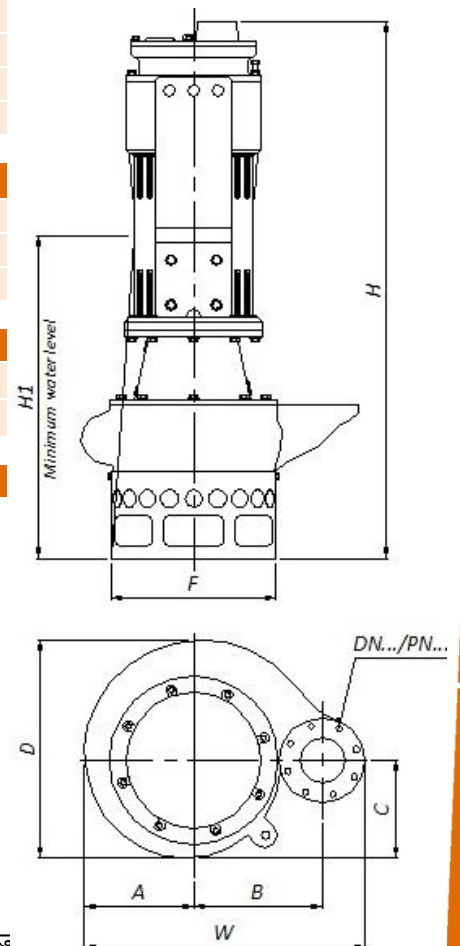

# EL60A-B

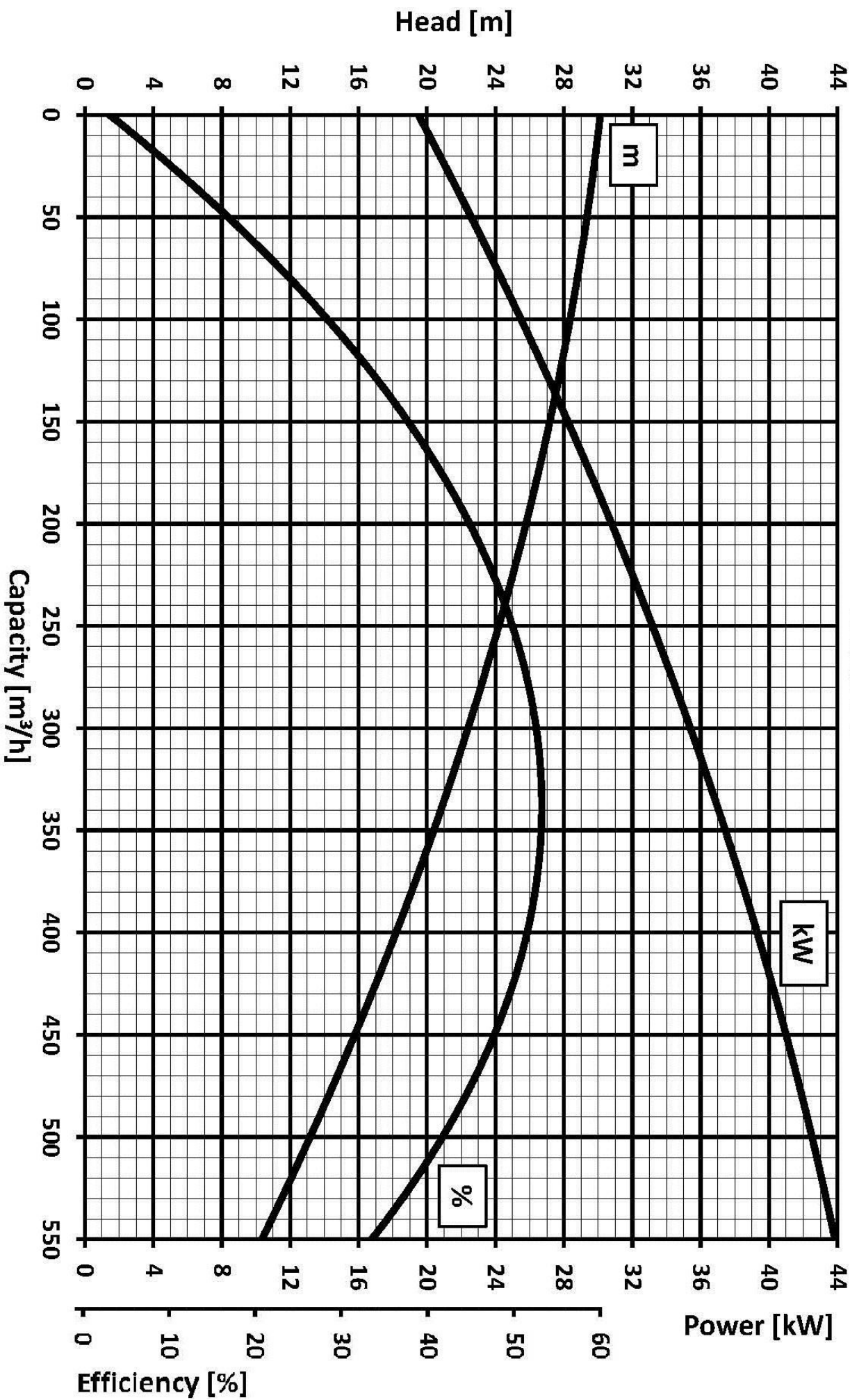

We reserve the right to make changes without notice